

# FULL WRAP

Desk Division



# FULL WRAP

Desk Division

The FULL WRAP acoustic partition wall follows the trend of dematerialization where all unnecessary parts of an acoustic workstation partition have been removed. The prominent vertical V-cuts provides an elegant finish. A simple, adaptable and functional system that works with every standard workstation.

## ARTIKELNUMMER

745.12.10.000.00

## DIMENSIONS

Length:	2792 mm	109.92"
Width:	590 mm	23.23"
Thickness:	12 mm	0.47"

## CONNECTION

FULL WRAP is held by powder coated round metal adaptors, which can be mounted on to any standard workstation tabletop.

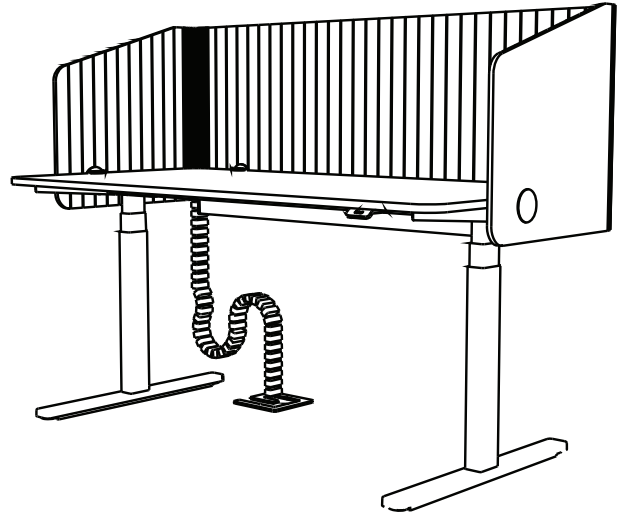

**SIDE**

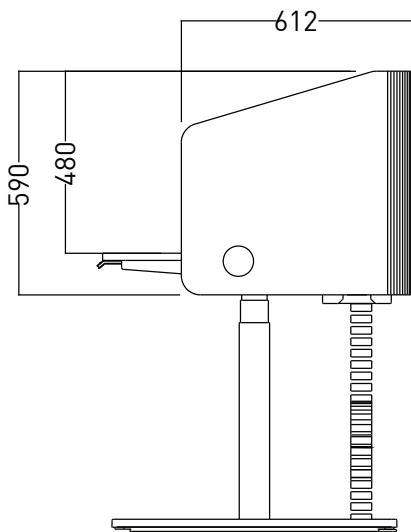

**FRONT**

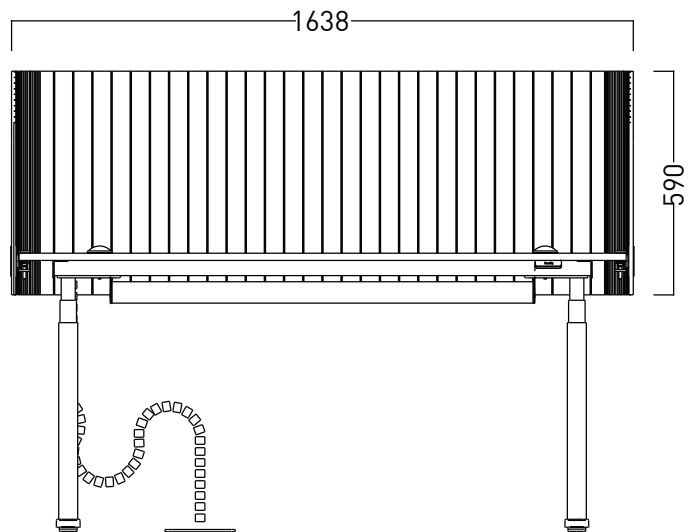

TECHNICAL DATA SHEET

# ARCHISONIC®

## Colour Families

ARCHISONIC® is a high-performance sustainable acoustic absorber made from upcycled plastic bottles which is Cradle to Cradle certified and LEED accredited.

ARCHISONIC® is manufactured at the highest quality standards, yet slight color and surface deviations caused by the high degree of recycled fiber are an inevitable part of the product characteristics and do not claim warranty services.

Material varies in colour when shown in monitor or in print. Please request a material sample to verify colours.

### QUIET NEUTRALS

12 mm

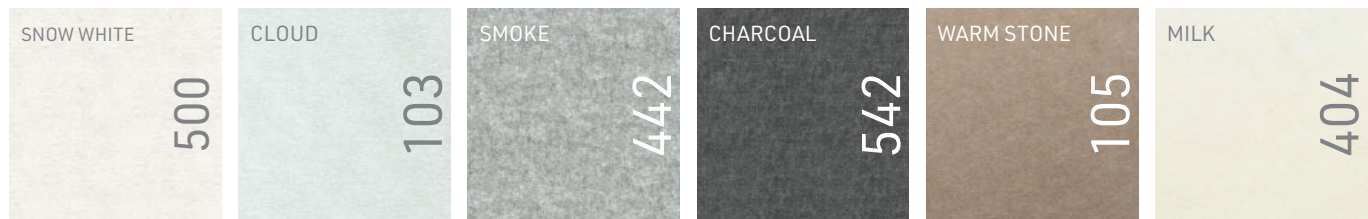

### WARM NEUTRALS

12 mm



### LIVING GREENS

12 mm

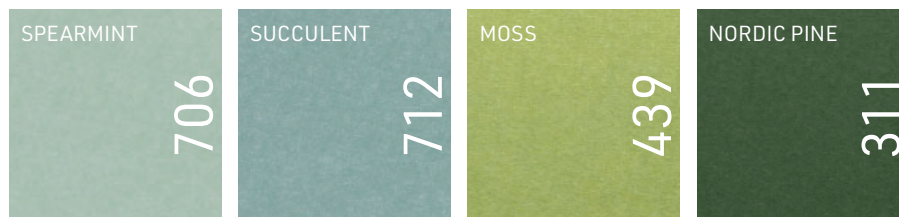

### ELEMENTAL BLUES

12 mm



## SOOTHING PASTELS

12 mm



## ELEGANT DARKS

12 mm



## ENERGETIC BRIGHTS

12 mm

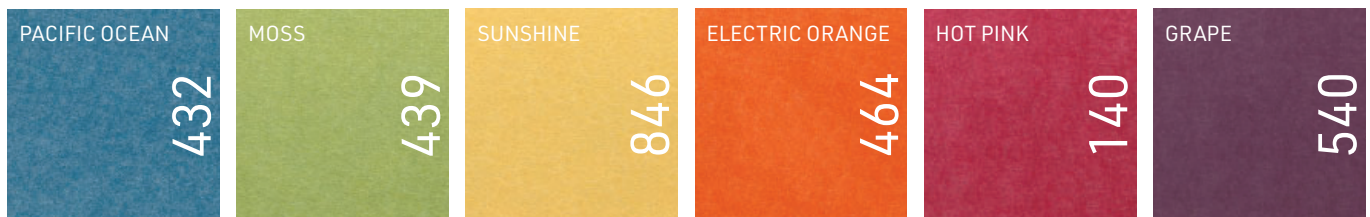

## PRIMARY PLAY

12 mm



## DIMENSIONS

ARCHISONIC® 24 mm 1800 x 2400 x 24 mm (70" x 94" x 0.94")  
ARCHISONIC® 12 mm 1200 x 2800 x 12 mm (47" x 10" x 0.47")

## COMPOSITION

100% PET (min. 60% post-consumer)

## FIRE TEST

DIN EN 13501-1 B-s1, d0  
ASTM E-84 Class A

## VOC EMISSION

CDPH 01350 Pass  
ISO 16000 (CDPH/EHLB/Standard Method V1.2.)  
EN 16516

## COLOUR FASTENESS

EN ISO 105-B02, A1 Grade 6

## SOUND ABSORPTION

DIN ISO 11654

24 mm aw 0.55 (no airgap)  
aw 0.65 (50 mm / 2" air gap)  
aw 0.90 (100 mm / 4" air gap)  
aw 0.95 (200 mm / 8" air gap)  
aw 0.95 (300 mm / 11" air gap).

12 mm aw 0.30 (no air gap)

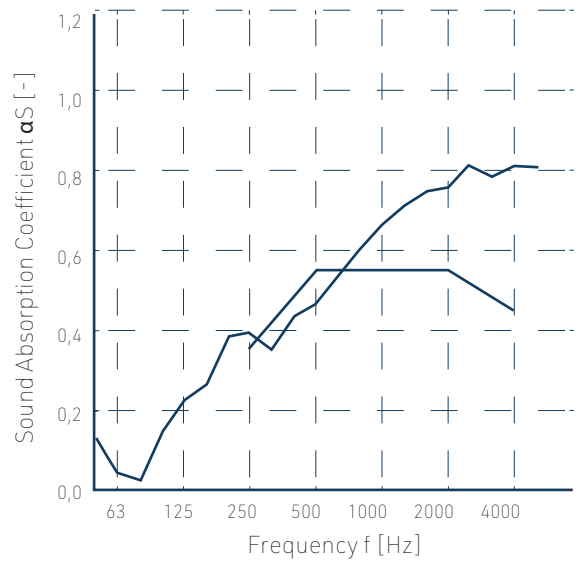

## MATERIAL REUTILISATION

ARCHISONIC® 24 mm 88 plastic bottles/m<sup>2</sup>  
ARCHISONIC® 12 mm 53 plastic bottles/m<sup>2</sup>

## ENVIRONMENTAL

Cradle to Cradle Certified™  
Product qualifies for LEED v4 specifications on VOC emissions in LEED EQ credit (Low-emitting products)

## SUPPORTED BY

Climate KIC

