

# Folding tables - Plica technical specification



**.mdd**

**.mdd has a leading position among manufacturers of office furniture with many awards that prove quality and continuously increase demand for it's products.**

The realities of today`s market require constant quality improvement at all levels of modern organization. This applies in particular to customer service, marketing, quality of products and also to quality of processes within the company.

Partnership relations among employees and with business partners form a base of economic growth and success of the company.

Constant investments in innovative machinery park, optimization of management systems and an expansion of production halls allow to minimize the lead times for the product of the highest quality.

**More than twenty years of experience in office furniture industry come with reference from a long list of companies and institutions to show their appreciation for an efficient and comprehensive service. .mdd is highly aware of the environment.**

Being located in the forest region with lake by it's side, .mdd takes the nature seriously and invests constantly in a modern and energy-efficient solutions to preserve the local life. Company puts emphasis on waste segregation and recycling. .mdd has been awarded for the exceptional care and involvement in waste disposal. All materials used are environmentally friendly and enjoy a high 95 % rate of being recycled.



**General informations:**

**Warranty:**

.mdd products - **5 years.**

Electrical components and fabric - **2 years.**

**Boards density:**

12 mm - 690 - 750 kg/m<sup>3</sup>

18 mm - 650 - 690 kg/m<sup>3</sup>

28 mm - 610 - 630 kg/m<sup>3</sup>

36 mm - 610 - 630 kg/m<sup>3</sup>

**Certificate - MFC:**



**Assembly:**

product delivered in separate elements

**Packing:**

cartboard

## Plica - folding tables

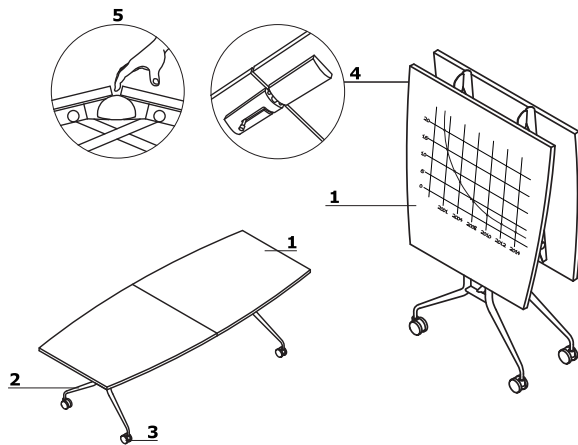

**1. Worktop** - MFC 28 mm, ABS edge

OPTIONS WITH EXTRA CHARGE:

\* worktop covered in nano - tech laminate FENIX, colour: black, 30mm worktop thickness; ABS edges, colour: black or with an additional fee - natural ash option

\* "dry - wipe board", colour: white; 27mm worktop thickness

**2. Leg** - powder coated steel, colour: white, black, aluminium or with an additional fee - chrome option

**3. Wheels with brake** - Ø100 mm

**4. Blocking bolt** - protecting against accidental folding

**5. Protection mechanism** against hand jamming during folding and unfolding of the table

Folding tables \*

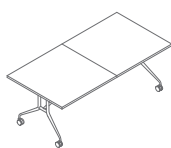

PCP01

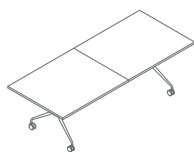

PCP02

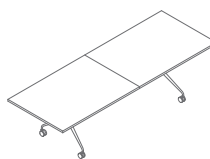

PCP03

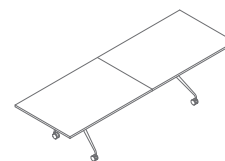

PCP04

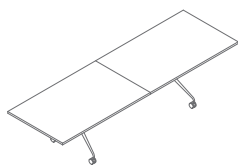

PCP05  
3200 / 1000 / 740

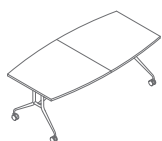

PCB01  
2000 / 1000 / 740

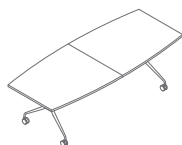

PCB02  
2400 / 1000 / 740

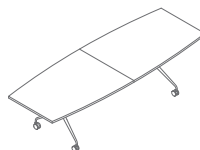

PCB03  
2800 / 1000 / 740

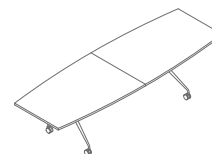

PCB04  
3000 / 1000 / 740

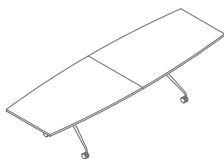

PCB05  
3200 / 1000 / 740

\* dimensions expressed in millimeters: width x depth x height

Folding tables \*

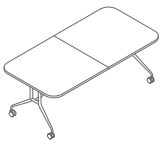

**PCZ01**  
2000 / 1000 / 740

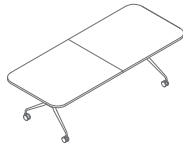

**PCZ02**  
2400 / 1000 / 740

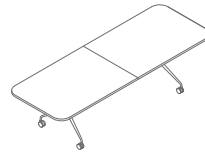

**PCZ03**  
2800 / 1000 / 740

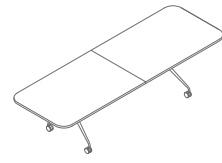

**PCZ04**  
3000 / 1000 / 740

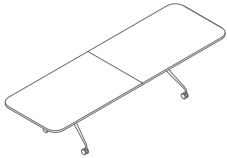

**PCZ05**  
3200 / 1000 / 740

\* dimensions expressed in millimeters: width x depth x height

<b>Folding tables Plica</b>	Date of preparation 01.03.2021	The data contained in this document is valid in the day of its preparation. Change of the product, as long as it does not affect the basic features of it, does not require consistent updates of the document.	page 5/6
			<b>products</b>

Top



14 Beech



26 Aluminum satinato



31 Canadian oak



34 Chestnut



39 Polar birch



64 Cocoa



67 White pastel



106 Lowland walnut



154 Anthracite



08 Black



167 Grey oak



168 Natural oak



Fenix black matte \*



185 Dry-wipe worktop \*

Frame



M009 Aluminum semi-mat RAL9006



M015 White semi-mat RAL9010



M115 Black semi-mat RAL9005



17 Chrome \*

\* OPTION WITH EXTRA CHARGE