

Baltic stool technical specification



.mdd

.mdd has a leading position among manufacturers of office furniture with many awards that prove quality and continuously increase demand for its products.

The realities of today's market require constant quality improvement at all levels of modern organization. This applies in particular to customer service, marketing, quality of products and also to quality of processes within the company. Partnership relations among employees and with business partners form a base of economic growth and success of the company.

Constant investments in innovative machinery park, optimization of management systems and an expansion of production halls allow to minimize the lead times for the product of the highest quality.

More than twenty years of experience in office furniture industry come with reference from a long list of companies and institutions to show their appreciation for an efficient and comprehensive service.

.mdd is highly aware of the environment.

Being located in the forest region with lake by its side, .mdd takes the nature seriously and invests constantly in a modern and energy-efficient solutions to preserve the local life. Company puts emphasis on waste segregation and recycling. .mdd has been awarded for the exceptional care and involvement in waste disposal. All materials used are environmentally friendly and enjoy a high 95 % rate of being recycled.



General informations:

Warranty:

.mdd products - **5 years**.
Electrical components and fabric - **2 years**.

Assembly:

the product comes pre-assembled

Packing:

cardboard

Certificate - fabric:



www.mdd.eu

Material composition *:

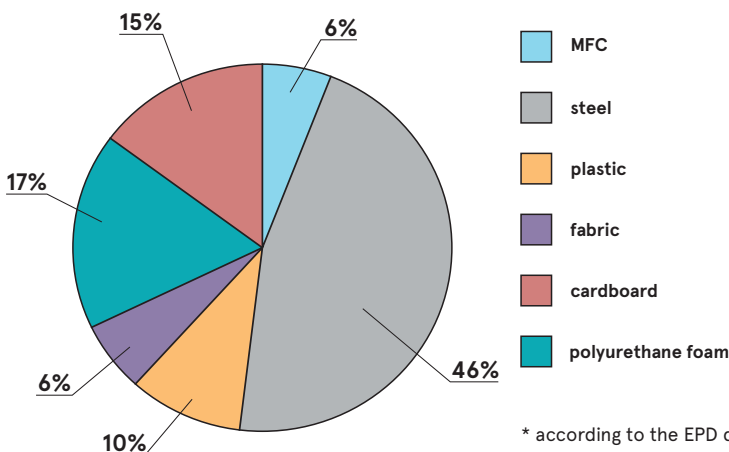

* according to the EPD document

Recyclability **

Recycling: 100% - Downcycling: 0%

Recycled content

34%

Co2 carbon footprint

31,1 kg

** average values for a representative of the group; values may vary for other products

Baltic stool	Date of preparation 02.12.2022	The data contained in this document is valid in the day of its preparation. Change of the product, as long as it does not affect the basic features of it, does not require consistent updates of the document.	page 2/11
			general informations

Technical specification

- 1. **Baltic Basic** - seat polypropylene
- 2. **Baltic Soft Duo** - seat upholstered + draped cushion - cut foam, density of 40 kg/m³, upholstered

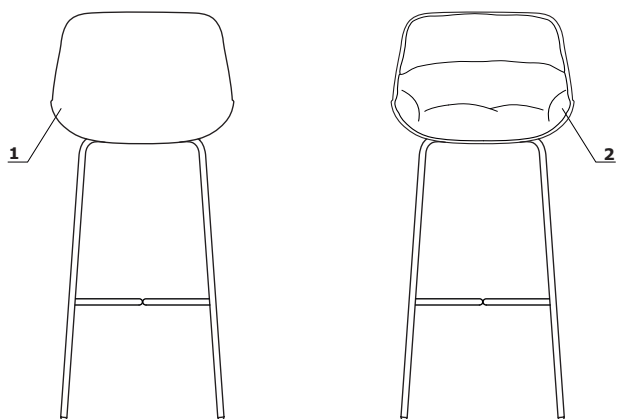

- max. load 120 kg

Bases

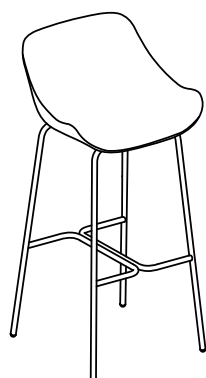

**BL1P4H
BL5P4H**

Base BL1P4H/BL5P4H:

- high stool
- frame made of tube Ø18 mm, wall thickness 2 mm, powder coated
- polypropylene feet

Dimensions

Base P4H

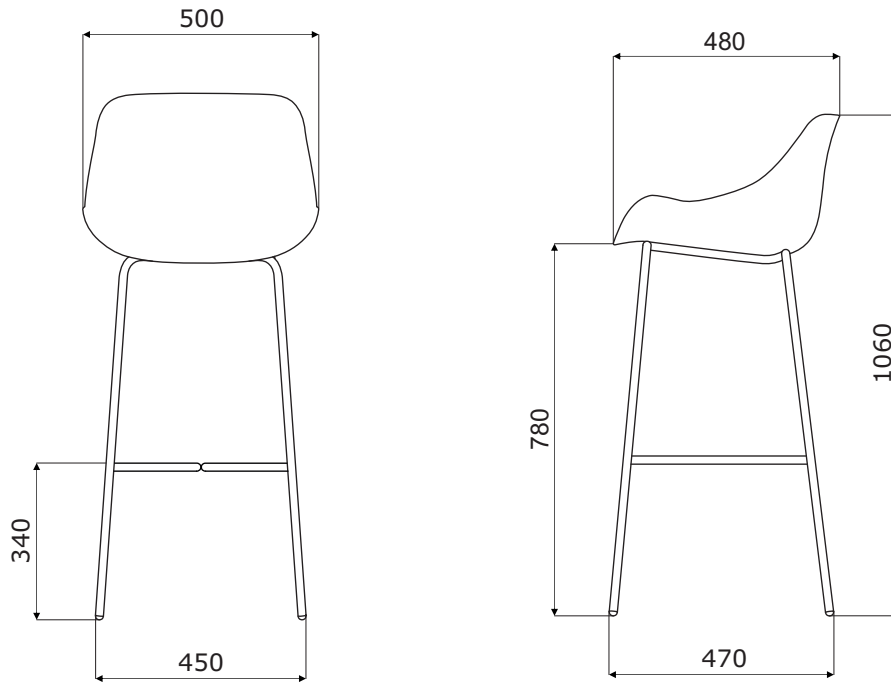

Baltic Basic - seat polypropylene *



BL1P4H
500 / 480 / 1060
6.8 kg

Baltic Soft Duo - seat upholstered + draped cushion *



BL5P4H
500 / 480 / 1060
6.8 kg

* dimensions expressed in millimeters: width x depth x height

Baltic stool	Date of preparation 02.12.2022	The data contained in this document is valid in the day of its preparation. Change of the product, as long as it does not affect the basic features of it, does not require consistent updates of the document.	page 5/11
			products

Fabric Medley - second price group



Technical data:

Material polyester 100%

Fabric weight 510 g/lm (16.45 oz./lin.yd.)

Abrasion resistance rubs BS EN ISO 12947-2, 75,000 cykli Martindale

Pilling resistance scale 1-5, max. 5, EN ISO 12945-2 (4)

Colour fastness to light scale 1-8, max. 8, EN ISO 105-B02 (5-7)

Colour fastness to rubbing scale 1-5, max. 5, EN ISO 105x12 (wet/dry (4-5/4-5))

Acoustic test sound absorption ISO 354

Flammability BS EN 1021-1 (cigarette)
BS 476 Part 7, Class 2
Class Uno UNI 9174 - UNI 8457
CA TB 117-2013
ASTM E 84 Class I

Fabric Atlantic * - second price group



Technical data:

Material polyester 100%

Fabric weight 530 g/lm (17.09 oz./lin.yd.)

Abrasion resistance rubs BS EN ISO 12947-2, 110,000 Martindale cycles

Pilling resistance scale 1-5, max. 5, EN ISO 12945-2 (4-5)

Colour fastness to light scale 1-8, max. 8, EN ISO 105-B02 (5-7)

Colour fastness to rubbing scale 1-5, max. 5, EN ISO 105x12 (wet/dry)

Flammability CA TB 117-2013
ASTM E 84 Class I
BS EN 1021-2 (match)
BS EN 1021-1 (cigarette)

Fabric Vita - second price group



Technical data:

Material Surface: 98,5% PVC, 1,5% PU
Substrate: 50% poliester, 50% Cotton

Fabric weight 850g/m2 ± 10% (1190G/lin. m ± 10%)

Abrasion resistance rubs BS EN ISO 5470-2, 100,000 Martindale cycles

Colour fastness to light 6 (ISO 105 - B02)

Colour fastness to rubbing wet: 4, dry: 4 (ISO 105 - X12)

Flammability BS EN 1021 - (cigarette)
BS EN 1021 - 2 (match)
BS 5852 - (Ignition Source 5)
BS 7176 - (Medium Hazard)

Flexes BS EN ISO 7854 - Method B, 400.000 Flexing cycles

Anti-microblal / Anti-fungal AATCC 147

* There is a possibility of ordering the product in full colour spectrum of Atlantic range, as per Gabriel's pattern book, within 8 weeks

Fabric Charles * - second price group



Technical data:

Material 100% polyester
Fabric weight 433g/m2
Abrasion resistance rubs 90,000 Martindale cycles (EN ISO 12947-2)
Pilling resistance EN ISO 12945-2, 5
Light fastness EN ISO 105-B02, 5
Rubbing fastness dry: 4-5, wet: 4-5, EN ISO 105x12
Flammability EN 1021, 1

Fabric Mica - second price group



Technical data:

Material post-consumer recycled polyester 97%, polyester 3%
Fabric weight 305 g/lm
Abrasion resistance rubs 60,000 rubs martindale (EN ISO 12947-2)
Pilling resistance scale 1-5, max. 5 - EN ISO 12945-2, 4-5
Light fastness scale 1-8, max. 8 - EN ISO 105-B02, 5-8
Rubbing fastness dry: 4-5, wet: 4-5, scale 1-5, max. 5 - EN ISO 105x12
Flammability CA TB 117-2013
 ASTM E 84 Class I
 BS EN 1021-1 Cigarette
 BS EN 1021-2 Match
 BS 476 Part 7 class I

* There is a possibility of ordering the product in full colour spectrum of Charles range, as per Dekoma pattern book, within the standard delivery time.

Fabric Go Check - second price group

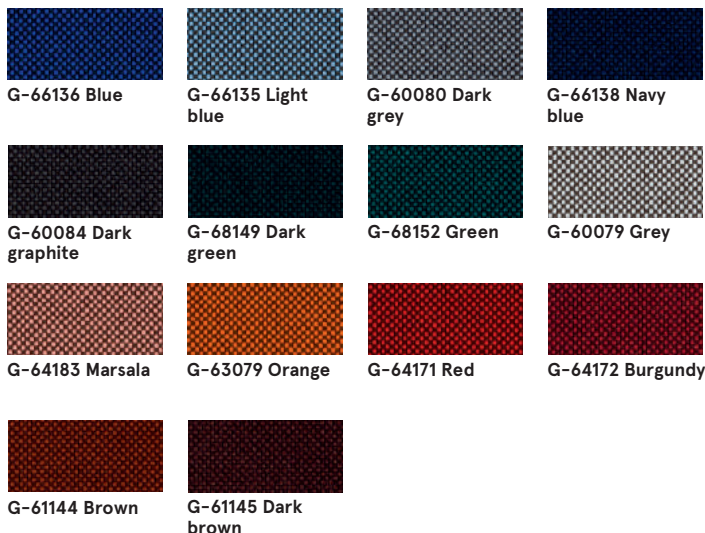

Technical data:

Material 100% Trevira CS
Fabric weight 435g/lm
Abrasion resistance rubs 80,000 rubs martindale (EN ISO 12947-2)
Pilling resistance scale 1-5, max. 5 - EN ISO 12945-2, 5
Light fastness scale 1-8, max. 8 - EN ISO 105-B02, 5-8
Rubbing fastness dry: 4-5, wet: 4-5, scale 1-5, max. 5 - EN ISO 105x12
Flammability BS EN 1021 1&2 Cigarette and Match
 BS EN 1021-1 Cigarette
 BS 5852 Crib 5
 BS 7176 Medium hazard
 DIN 4102 - B1
 NFP 92-503/504/505 M1
 ÖNORM A3800-B1-B3825-Q1 UK
 Class Uno UNI 9175 Class 1 I EMME
 FAR/JAR 25.853 (a) (i) (ii)
 CA TB 117-2013
 DIN EN 13501-1 B-s1,d0
 AM 18 - NF D 60-013-(only for fabric)

Fabric Synergy - third price group



Technical data:

Composition 95% Virgin Wool, 5% Polyamide
Fabric weight 400g/m2 (560g/lm)
Abrasion resistance rubs 100.000 Martindale cycles
Colour fastness to light ISO 105 - B02 5
Colour fastness to rubbing EN ISO 105x12 4-4
 (dry/wet)
Flammability EN 1021 - 1&2 (cigarette & match)
 BS 7176 Low Hazard
 NF D 60-013
 ÖNORM B 3825 & A 3800-1 (58 kg/m3 CMHR Foam)
 UNI 9175 Classe 1 IM
 EN 13501-1 Adhered Class D, s1, d0
 IMO FTP Code (Part 8)
 The Furniture and Furnishing (Fire) (Safety) Regulations 1988 (Domestic Cigarette and Match)
 BS 5852 Ignition Source 5 when FR treated
 BS 7176 Medium Hazard when FR treated
 EN 13501-1 Adhered Class B, s1, d0 when FR treated
 EN 13501-1 Un-adhered Class D, s2, d0 when FR treated
 BS 5867-2: Type B Curtains & Drapes when FR treated

Fabric Silvertex – third price group

There is a possibility of ordering the product in full colour spectrum of Silvertex range, as per Spradling’s pattern book, within 15 working days.

Technical data:

Material	Topcoat: 100% Vinyl Backing: 100% Polyesterr Hi-Loft™
Fabric weight	685 gr/m2
Abrasion resistance	>300,000 cycles Martindale
UV-resistance	>= 7 (1000 hours, blue wool scale)
Cold Crack resistance	-23°C
Flame retardancy	NF P 92-503 / M2 EN 1021, Part 1&2 DIN 4102 B2 ÖNORM B 3825, Gruppe I – Schwerbrennbares Verhalten ÖNORM A 3800, Teil I, Qualmbildungsklasse QI – schwachqualmend IMO Res. MSC.307 (88) (2010 FTP Code) Annex I Part 8 (MED) Marine Equipment Directive in its current valid version UNI 91 75 (1987) / UNI 9175/FAI (1994) Classe I.IM (uno I EMME) UNE 23.727-90 IR /M2 EN 71-2: 2006+AI: 2007 Safety of Toys – Part 2: Flammability ECE R 11 8 (replaces Directive 95/28/EC) FMVSS 302 FAR 25/853
Antimicrobial	Antifungal Protection, Antibacterial Protection, Antimycotic Protection

Fabric Tessa – third price group



Technical data:

Material	95% polyester, 5% acrylic
Fabric weight	500g/m2
Abrasion resistance rubs	75,000 Martindale cycles (EN ISO 12497-2)
Pilling resistance	EN ISO 12945-2, 4-5
Light fastness	EN ISO 105-B02, 4
Rubbing fastness	dry: 4-5, wet: 4-5, EN ISO 105x12

Fabric Oceanic – third price group



Technical data:

Material	100% post-consumer recycled polyester
Fabric weight	497g/m2
Abrasion resistance rubs	100,000 Martindale cycles (EN ISO 12947-2)
Pilling resistance	EN ISO 12945-2, 5
Light fastness	EN ISO 105-B02, 5
Rubbing fastness	dry: 4, wet: 4, EN ISO 105x12
Flammability	EN 1021, - 1&2 (Cigarette and Match) BS 7176 Low Hazard BS 5852 Ignition Source BS 7176 Medium Hazard

Fabric Quest - third price group

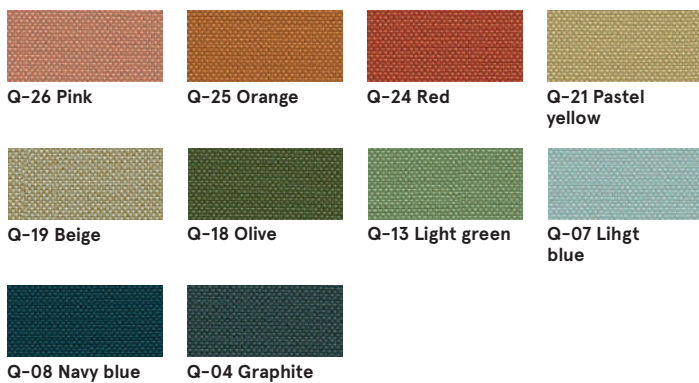

Technical data:

Material 100% post-consumer recycled polyester
Fabric weight 330g/m2
Abrasion resistance rubs 100,000 Martindale cecles (EN ISO 12947-2)
Light fastness EN ISO 105-B02, 4-6
Rubbing fastness dry: 4, wet: 4, EN ISO 105x12
Flammability EN 1021, - 1&2 (Cigarette and Match)
 BS 7176 Low Hazard
 UNI 9175 Classe 1 IM
 BS 476 Part 7 Class 1Y (Adhered)
 EN 13501-1 Adhered Class B, s1, d0
 EN 13501-1 Un-adhered Class B, s1, d0
 BS 5852 Ignition Source 5 with EnviroFlam5
 BS 7176 Medium Hazard with EnviroFlam5
 IMO FTP Code (Part 8) with EnviroFlam5

Fabric Grain - third price group



Technical data:

Material 92% post-consumer recycled polyester
 8% polyester
Fabric weight 615g/m2
Abrasion resistance rubs 100,000 Martindale cecles (EN ISO 12947-2)
Pilling resistance EN ISO 12945-2, 5
Light fastness EN ISO 105-B02, 5-7
Rubbing fastness dry: 4-5, wet: 4-5, EN ISO 105x12
Flammability BS EN 1021 1&2 Cigarette and Match
 CA TB 117-2013

Fabric Atlas - fourth price group



Technical data:

Material 90% new wool, 10% nylon
Fabric weight 286g/m2, 400g/lm
Abrasion resistance rubs 100,000 cykli Martindale, EN ISO 12947
Colour fastness to light ISO 105 B02: 6-7
Colour fastness to rubbing ISO 105-X12:2001, (wet/dry) 4-5/4-5
Flammability BS EN 1021-2 Match, BS EN 1021-1 Cigarette,
 BS 5 5852 Crib 5, BS 5852 ignition source 3,
 BS 5852 Part 1, NF D 60 013, UNI 9175 1IM,
 US Cal. Bull. 117-2013









Leather - fourth price group









Technical data:

Material Leather type - corrected grain leather
 Type of finishing - pigmented leather
Abrasion resistance rubs Dry: 500 cycles - min. 4 grey scale
 Wet: 250 cycles - min. 4 grey scale
 UNI EN ISO 11640
Colour fastness to light Light fastness: min. 4 grey scale,
 UNI ISO 105-802
Flammability No ignition
 UNI EN 1021-1-2006
 BS EN 1021-1-2006

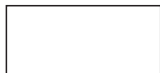
Metal - frame

			
M013 Burgundy semi-matt RAL3007	M015 White semi-matt RAL9010	M026 Olive semi-matt RAL6013	M028 Brick red semi-matt RAL04040
			
M029 Yellow semi-matt RAL0807060	M030 Beige semi-matt RAL0608005	M115 Black semi-matt RAL9005	M154 Anthracite semi-matt RAL7043

Seat - polypropylene

			
Black RAL9005	White RAL9010	Anthracite RAL7043	Olive RAL6013
			
Beige RAL0608005	Yellow RAL0807060	Burgundy RAL3007	Brick red RAL04040