

Symbol		Dimensions					kg m3 pcs	Composition elements
		W1	W2	D1	D2	H		
AT24		2840	770			750	98 kg 1.466 m3 4 pcs	AT02L+AT02P+2xAT03

Extra charge						
III Price group	IV price group					
X	X					

Symbol		Dimensions					kg m3 pcs	Composition elements
		W1	W2	D1	D2	H		
AT11		3740	770			750	131 kg 1.894 m3 6 pcs	AT02L+AT04+AT02P+3xAT03

Extra charge						
III Price group	IV price group					
X	X					

Symbol		Dimensions					kg m3 pcs	Composition elements
		W1	W2	D1	D2	H		
AT15		4640	770			750	164 kg 2.321 m3 8 pcs	AT02L+2xAT04+AT02P+4xAT03

Extra charge						
III Price group	IV price group					
X	X					

Symbol		Dimensions					kg m3 pcs	Composition elements
		W1	W2	D1	D2	H		
AT23		2310	2310	1540	1540	750	133 kg 2.186 m3 6 pcs	AT02L+AT05+AT02P+2xAT03+AT06

Extra charge						
III Price group	IV price group					
X	X					

Symbol		Dimensions					kg m3 pcs	Composition elements
		W1	W2	D1	D2	H		
AT08		3210	2310	1540	2440	750	166 kg 2.614 m3 8 pcs	AT02L+AT04+AT05+AT02P+3xAT03+AT06

Extra charge						
III Price group	IV price group					
X	X					

Symbol		Dimensions					kg m3 pcs	Composition elements
		W1	W2	D1	D2	H		
AT16		4110	3210	2440	3340	750	232 kg 3.469 m3 12 pcs	AT02L+3xAT04+AT05+AT02P+5xAT03+AT06

Extra charge						
III Price group	IV price group					
X	X					

Symbol		Dimensions					kg m3 pcs	Composition elements
		W1	W2	D1	D2	H		
AT26		3210	3210	2440	2440	750	199 kg 3.041 m3 10 pcs	AT02L+2xAT04+AT05+AT02P+4xAT03+AT06

Extra charge						
III Price group	IV price group					
X	X					

Symbol		Dimensions					kg m3 pcs	Composition elements
		W1	W2	D1	D2	H		
AT13		1940	1280			750	86 kg 1.118 m3 4 pcs	2xAT01+2xAT04+AT03

Extra charge						
III Price group	IV price group					
X	X					

Symbol		Dimensions					kg m3 pcs	Composition elements
		W1	W2	D1	D2	H		
AT10		2840	1280			750	118 kg 1.577 m3 6 pcs	2xAT01+4xAT04+2xAT03

Extra charge						
III Price group	IV price group					
X	X					

Symbol		Dimensions					kg m3 pcs	Composition elements
		W1	W2	D1	D2	H		
AT14		3740	1280			750	150 kg 2.035 m3 8 pcs	2xAT01+6xAT04+3xAT03

Extra charge						
III Price group	IV price group					
X	X					

Symbol		Dimensions					kg m3 pcs	Composition elements
		W1	W2	D1	D2	H		
AT22		2820	2820	1540	1540	750	162 kg 2.586 m3 8 pcs	2xAT01+4xAT04+AT05+AT07+2xAT03+AT06

Extra charge						
III Price group	IV price group					
X	X					

Symbol		Dimensions					kg m3 pcs	Composition elements
		W1	W2	D1	D2	H		
AT09		2820	3720	2440	1540	750	194 kg 3.044 m3 10 pcs	2xAT01+6xAT04+AT05+AT07+3xAT03+AT06

Extra charge						
III Price group	IV price group					
X	X					

Symbol		Dimensions					kg m3 pcs	Composition elements
		W1	W2	D1	D2	H		
AT25		3720	3720	2440	2440	750	226 kg 3.503 m3 12 pcs	2xAT01+8xAT04+AT05+AT07+4xAT03+AT06

Extra charge						
III Price group	IV price group					
X	X					

Symbol		Dimensions					kg m3 pcs	Composition elements
		W1	W2	D1	D2	H		
AT12		1280	1040			450	54 kg 0.66 m3 2 pcs	2xAT01

Extra charge						
III Price group	IV price group					
X	X					

Symbol		Dimensions					kg m3 pcs	Composition elements
		W1	W2	D1	D2	H		
AT20		2820	2820			750	128 kg 3.023 m3 4 pcs	4xAT07+4xAT06

Extra charge						
III Price group	IV price group					
X	X					

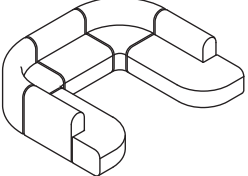
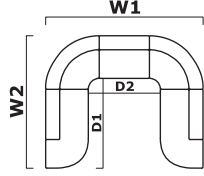
							kg m3 pcs	Composition elements
Symbol		W1	W2	D1	D2	H		
AT27		2700	2310	1540	1160	750	201 kg 3.334 m3 10 pcs	AT02L+2xAT05+AT04+AT02P+3xAT03+2xAT06

Extra charge						
III Price group	IV price group					
X	X					

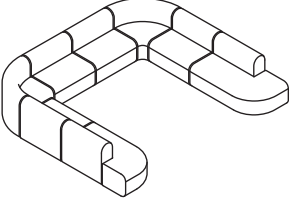
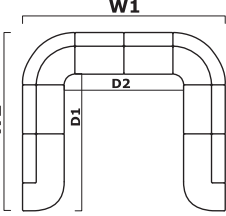
							kg m3 pcs	Composition elements
Symbol		W1	W2	D1	D2	H		
AT21		3600	3210	2440	2060	750	300 kg 4.617 m3 16 pcs	AT02L+4xAT04+2xAT05+AT02P+6xAT03+2xAT06

Extra charge						
III Price group	IV price group					
X	X					

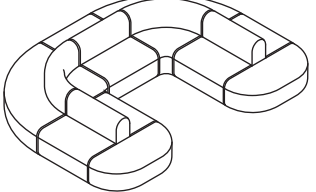
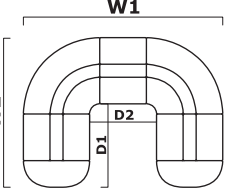
							kg m3 pcs	Composition elements
Symbol		W1	W2	D1	D2	H		
AT17		3720	2820	1540	1160	750	335 kg 5.582 m3 17 pcs	2xAT01+6xAT04+2xAT05+2xAT07+3xAT03+2xAT06





Extra charge						
III Price group	IV price group					
X	X					

Symbol		Dimensions					kg m3 pcs	Composition elements
		W1	W2	D1	D2	H		
AT18		5250	5250			750	451 kg 7.715 m3 23 pcs	2xAT01+8xAT04+3xAT05+3xAT07+4xAT03+3xAT06

Extra charge						
III Price group	IV price group					
X	X					

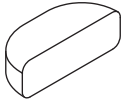
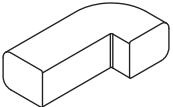
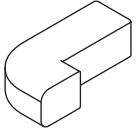
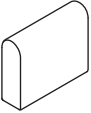
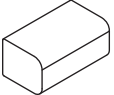
Symbol		Dimensions					kg m3 pcs	Composition elements
		W1	W2	D1	D2	H		
AT19		4740	4740			750	289 kg 4.984 m3 14 pcs	AT02L+2xAT05+2xAT04+AT07+AT02P+4xAT03+3xAT06

Extra charge						
III Price group	IV price group					
X	X					

Composition elements							
	Symbol		Dimensions			kg m3 pcs	Comments
			Width	Depth	Height		
	AT01		1280	520	450	27 kg 0.33 m3 1 pcs	
	AT02L		1420	770	450	32 kg 0.535 m3 1 pcs	
	AT02P		1420	770	450	32 kg 0.535 m3 1 pcs	
	AT03		900	510	450	17 kg 0.198 m3 1 pcs	
	AT04		900	510	450	16 kg 0.229 m3 1 pcs	
	AT05		910	560	450	12 kg 0.254 m3 1 pcs	
	AT06		1270	450	750	23 kg 0.467 m3 1 pcs	
	AT07		1990	780	450	32 kg 0.756 m3 1 pcs	

Extra charge						
III Price group	Mediabox	IV price group				
X	X	X				
X	X	X				
X	X	X				
X		X				
X	X	X				
X		X				
X	X	X				

Desks							
	Symbol		Dimensions			kg m3 pcs	Comments
			Width	Depth	Height		
	AT01S		473	250	630	2.8 kg 0.087 m3 1 pcs	

Extra charge							