

Viga

technical specification



.mdd

.mdd has a leading position among manufacturers of office furniture with many awards that prove quality and continuously increase demand for it's products.

The realities of today`s market require constant quality improvement at all levels of modern organization. This applies in particular to customer service, marketing, quality of products and also to quality of processes within the company. Partnership relations among employees and with business partners form a base of economic growth and success of the company.

Constant investments in innovative machinery park, optimization of management systems and an expansion of production halls allow to minimize the lead times for the product of the highest quality.

More than twenty years of experience in office furniture industry come with reference from a long list of companies and institutions to show their appreciation for an efficient and comprehensive service.

.mdd is higly aware of the environment.

Being located in the forest region with lake by itis side, .mdd takes the nature seriously and invests constantly in a modern and energy-efficient solutions to preserve the local life. Company puts emphasis on waste segregation and recycling. .mdd has been awarded for the exceptional care and involvement in waste disposal. All materials used are environmentally friendly and enjoy a high 95 % rate of being recycled.



General informations:

Warranty:

.mdd products - **5 years.**
Electrical components and fabric - **2 years.**

Certificate - MFC:



Assembly:

product delivered in separate elements

Packing:

cardboard, foam wrap,
honeycomb texture

Compliant with standards:

PN-EN 527-2:2017-02
PN-EN 14073-2:2006

Material composition *:

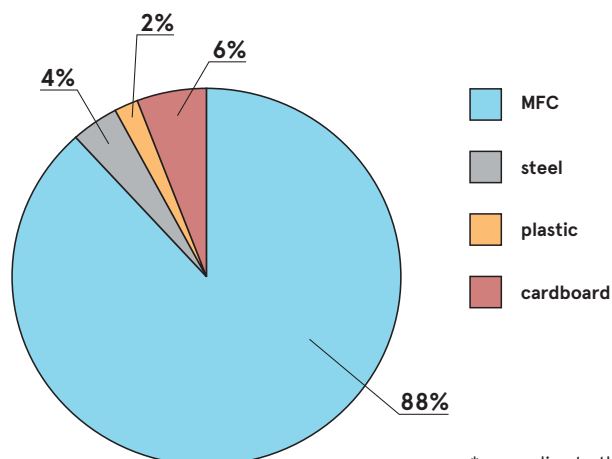

* according to the EPD document

Recyclability **

Recyclable: 10% - Downcyclable: 90%

Recycled content

4%

Co2 carbon footprint

112,5 kg

** average values for a representative of the group; values may vary for other products

Desks - worktop

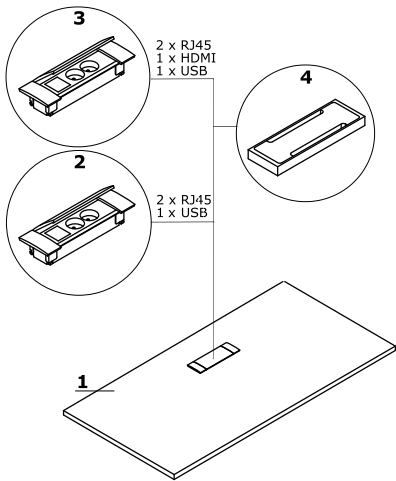

1. Worktop - 30 mm thick, veneer/HPL

OPTIONS WITH EXTRA CHARGE:

- 2. Mediabox M06 - 2x230V+USB charger, colour: black
- 3. Mediabox M06H - 2x230V+HDMI+USB, colour: black
- 4. Top access M10 - colour: FENIX - black matte, MDF
- 5. Cable way - the width of the opening is proportional to the width of the worktop

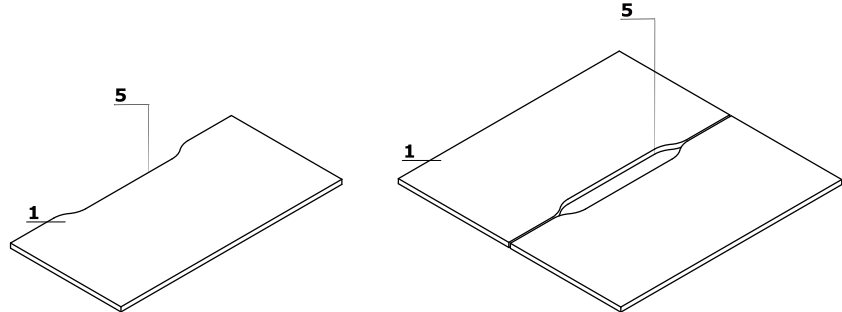

Frame

- 1. Leg - wood, profile 80x40 mm
- 2. Frame - anodised aluminium, colour: black; spacer 30 mm between top and frame

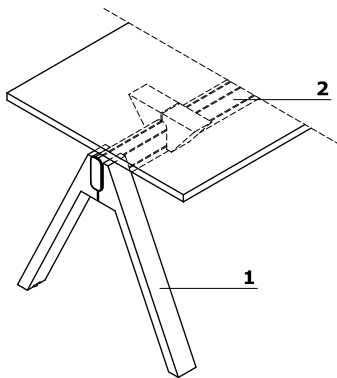

Extensions - for bench desks

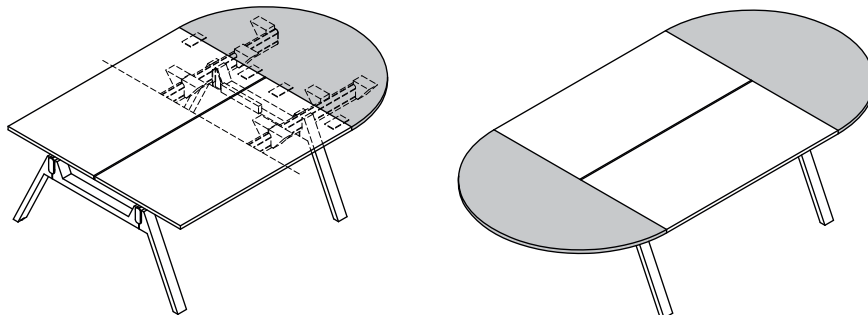

option with extra charge

Desk with managerial cabinet

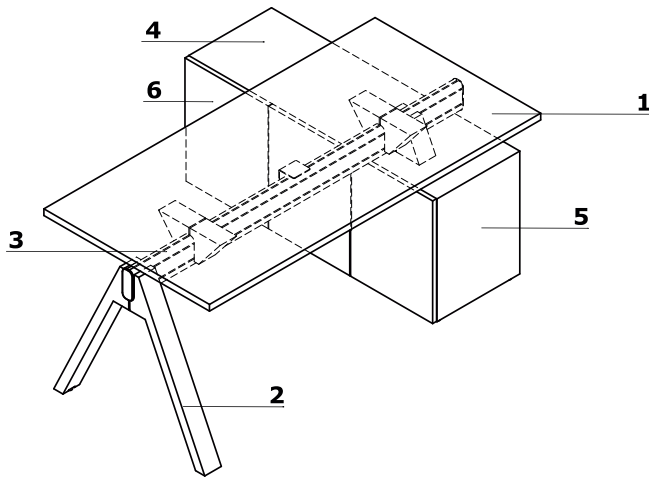

1. **Worktop** - 30 mm thick, veneer/HPL
2. **Leg** - wood, profile 80x40 mm
3. **Frame** - anodised aluminium, colour: black; spacer 30 mm between top and frame
4. **Top** - 19 mm thick, veneer
5. **Body** - 19 mm thick, veneer
6. **Front** - Push-to-Open, 19 mm thick, veneer

Executive desks - worktop

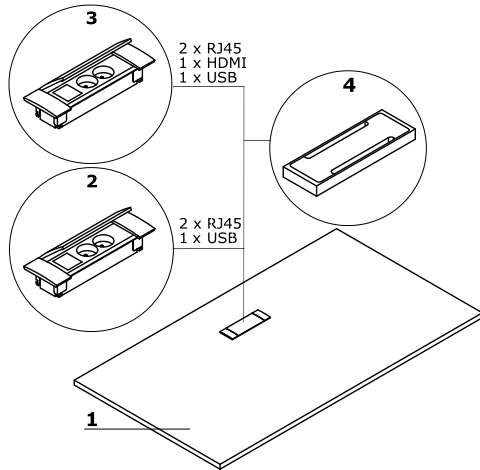

1. **Worktop** - 30 mm thick, veneer/HPL

OPTIONS WITH EXTRA CHARGE:

- 2. **Mediabox M06** - 2x230V+USB charger, colour: black
- 3. **Mediabox M06H** - 2x230V+HDMI+USB, colour: black
- 4. **Top access M10** - colour: FENIX - black matte, MDF

Frame

- 1. **Leg** - wood, profile 80x40 mm
- 2. **Frame** - anodised aluminium, colour: black; spacer 30 mm between top and frame

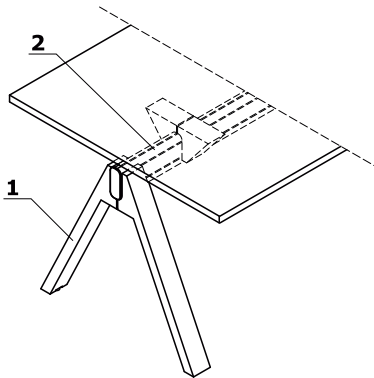

Storages

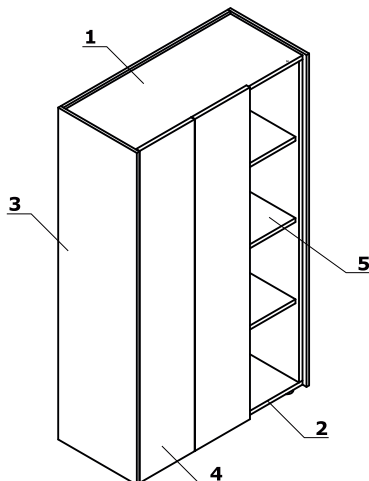

- 1. **Top** - 20 mm thick, HPL - Fenix
- 2. **Base** - 19 mm thick, veneer
- 3. **Body outside** - 14 mm thick, HPL - Fenix
- 4. **Front** - Push-to-Open, 19 mm thick, veneer
- 5. **Shelf** - 19 mm thick, protection against accidental falling-out, veneer

Desk with managerial cabinet

1. **Worktop** - 30 mm thick, veneer/HPL
2. **Modesty panel** - 13 mm thick, veneer; handle - powder coated steel, colour: black

PEDESTAL:

3. **Top** - 19 + 14 mm thick, veneer/HPL
4. **Base** - 19 mm thick, veneer
5. **Body outside** - 14 mm thick, HPL - Fenix
6. **Body inside** - 19 mm thick, veneer
7. **Front** - 13 mm thick, veneer
8. **MFC drawer** - ball runners, max load 25kg, 100% extraction; soft closing
9. **Shelf** - 19 mm thick, protection against accidental falling-out, veneer

MANAGERIAL STORAGE:

10. **Top** - 19 + 14 mm thick, veneer/HPL
11. **Base** - 19 mm thick, veneer
12. **Body outside** - 14 mm thick, HPL - Fenix
13. **Body inside** - 19 mm thick, veneer
14. **Sliding front** - 18 +13 mm thick, soft-closing system, veneer
15. **MFC drawer** - ball runners, 100% extraction; soft closing
16. **Patent lock**

DESK WITH MANAGERIAL CABINET (CABINET WITH ACCESS FROM BOTH SIDES):

17. **Top** - 19 + 14 mm thick, veneer/HPL
18. **Base** - 19 mm thick, veneer
19. **Body outside** - 14 mm thick, HPL - Fenix
20. **Body inside** - 19 mm thick, veneer
21. **Sliding front** - 18 +13 mm thick, soft-closing system, veneer
22. **MFC drawer** - ball runners, 100% extraction; soft closing
23. **Patent lock**

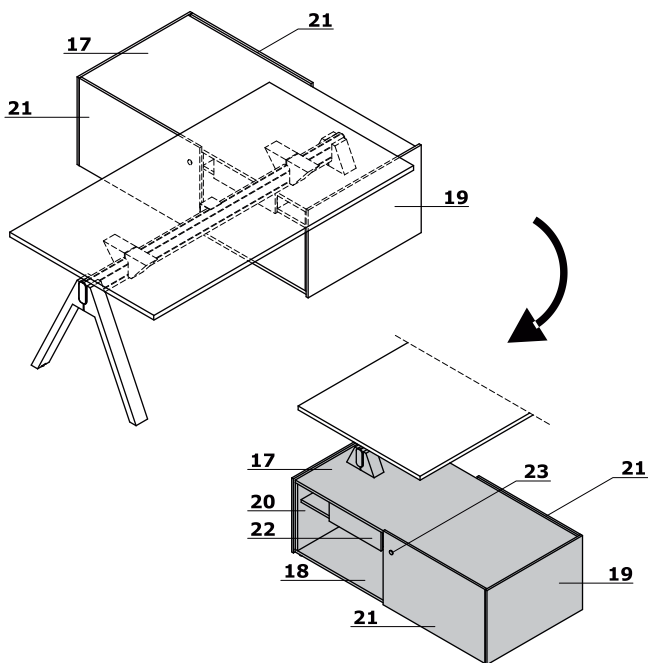
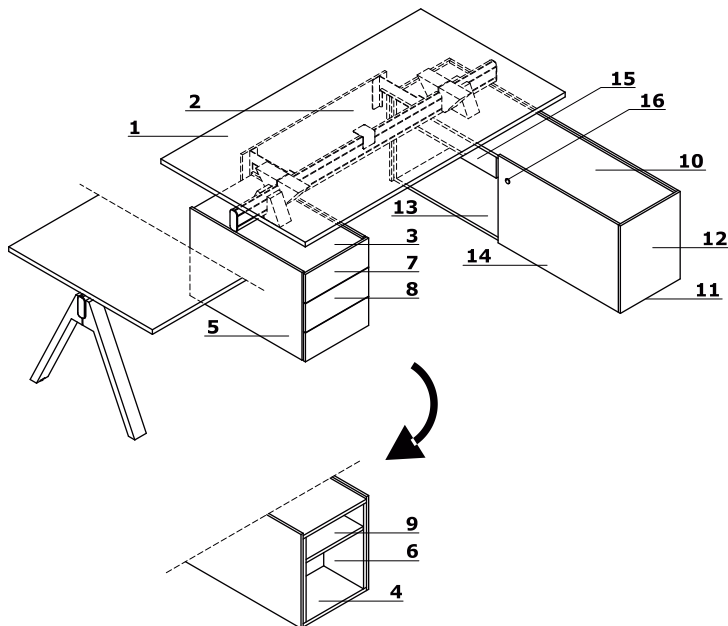

Pedestals

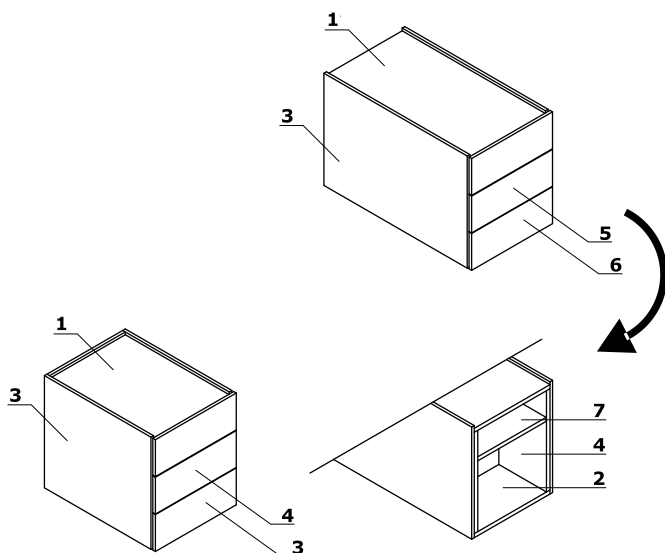

- 1. Top - 19 + 14 mm thick, veneer/HPL
- 2. Base - 19 mm thick, veneer
- 3. Body outside - 14 mm thick, HPL - Fenix
- 4. Body inside - 19 mm thick, veneer
- 5. Front - 13 mm thick, veneer
- 6. MFC drawer - ball runners, 100% extraction; soft closing
- 7. Shelf - 19 mm thick, protection against accidental falling-out, veneer

Meeting tables

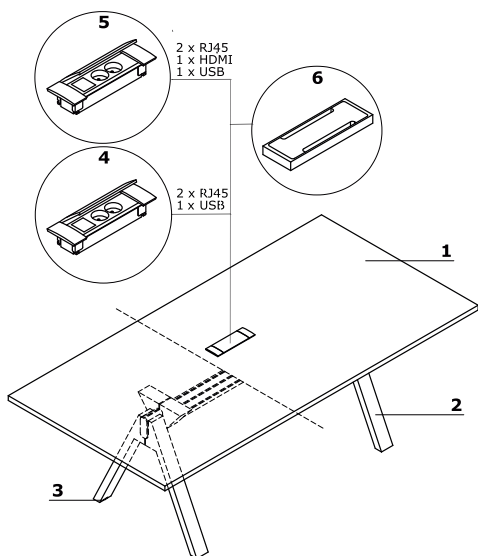

- 1. Worktop - 30 mm thick, veneer/HPL
- 2. Leg - wood, profile 80x40 mm
- 3. Leveling - 5 mm range

OPTIONS WITH EXTRA CHARGE:

- 4. Mediabox M06 - 2x230V+USB charger, colour: black
- 5. Mediabox M06H - 2x230V+HDMI+USB, colour: black
- 6. Top access M10 - colour: FENIX - black matte, MDF

Mediabox location

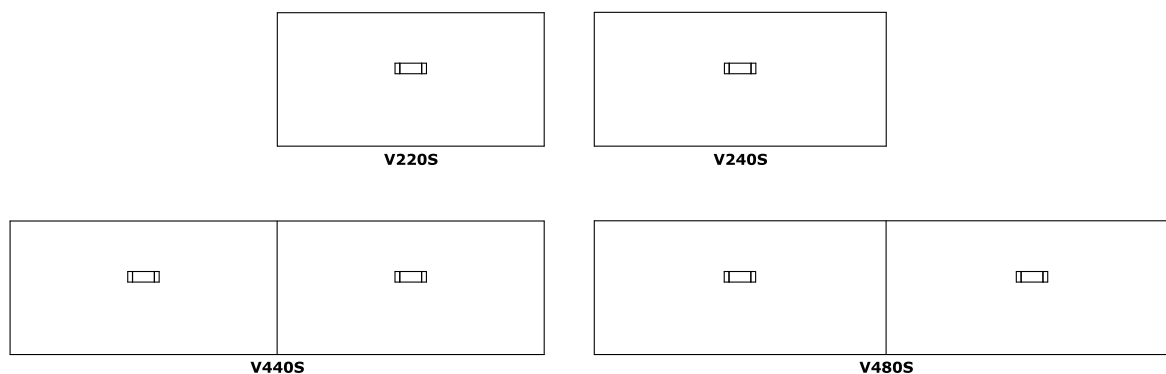

High tables

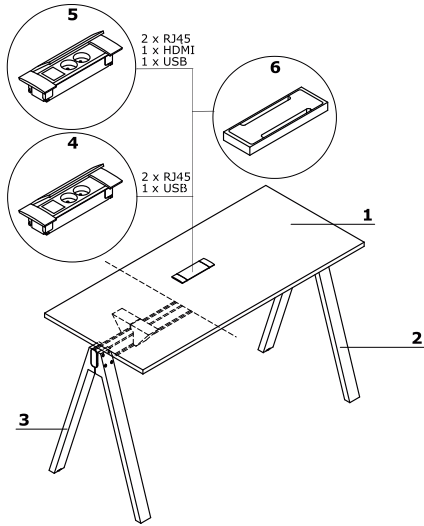

- 1. **Worktop** - 30 mm thick, veneer/HPL
- 2. **Leg** - wood, profile 80x40 mm
- 3. **Leveling** - 5 mm range

OPTIONS WITH EXTRA CHARGE:

- 4. **Mediabox M06** - 2x230V+USB charger, colour: black
- 5. **Mediabox M06H** - 2x230V+HDMI+USB, colour: black
- 6. **Top access M10** - colour: FENIX - black matte, MDF

Desks *



V16
1600 / 800 / 740
72 kg

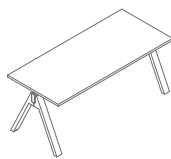

V18
1800 / 800 / 740
139.31 kg

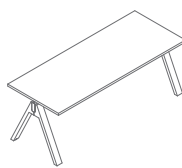

V20
2000 / 800 / 740
86.1 kg

Bench desks *

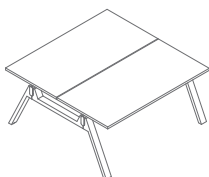

V216
1600 / 1610 / 740
148 kg

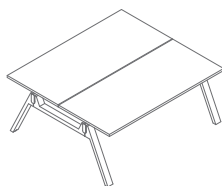

V218
1800 / 1610 / 740
162.1 kg

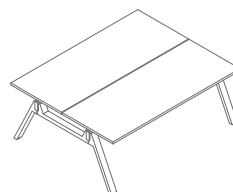

V220
2000 / 1610 / 740
176.2 kg

Extension units - straight desk *

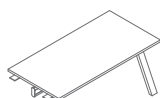

V16L
1600 / 800 / 740
68.3 kg

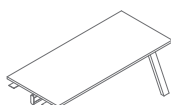

V18L
1800 / 800 / 740
135.61 kg

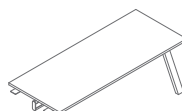

V20L
2000 / 800 / 740
82.4 kg

Extension units - bench *

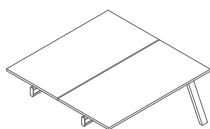

V216L
1600 / 1610 / 740
142 kg

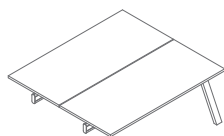

V218L
1800 / 1610 / 740
156.1 kg

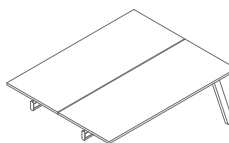

V220L
2000 / 1610 / 740
170.2 kg

* dimensions expressed in millimeters: width x depth x height

Desk with managerial cabinet *

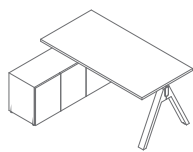

V163L
1600 / 1300 / 740
112.5 kg

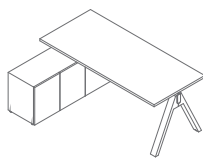

V183L
1800 / 1300 / 740
119.55 kg

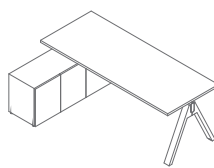

V203L
2000 / 1300 / 740
126.6 kg

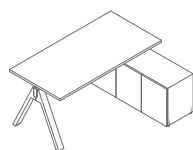

V163P
1600 / 1300 / 740
112.5 kg

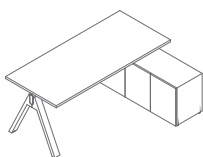

V183P
1800 / 1300 / 740
119.55 kg

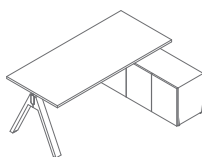

V203P
2000 / 1300 / 740
126.6 kg

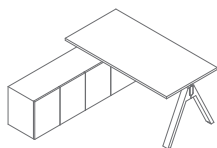

V164L
1600 / 1700 / 740
123.5 kg

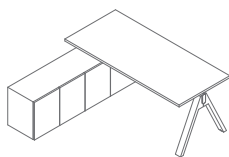

V184L
1800 / 1700 / 740
130.55 kg

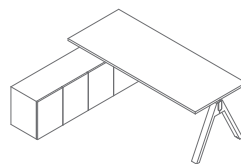

V204L
2000 / 1700 / 740
137.6 kg

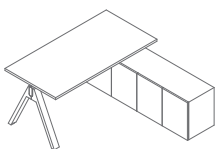

V164P
1600 / 1700 / 740
123.5 kg

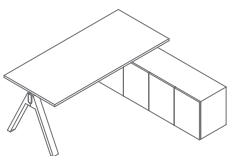

V184P
1800 / 1700 / 740
130.55 kg

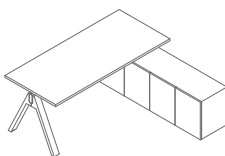

V204P
2000 / 1700 / 740
137.6 kg

* dimensions expressed in millimeters: width x depth x height

Desk with managerial cabinet *

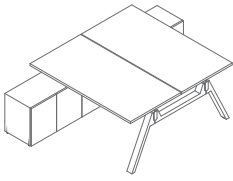

V1623
1600 / 2400 / 740
237 kg

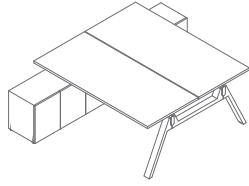

V1823
1800 / 2400 / 740
251.1 kg

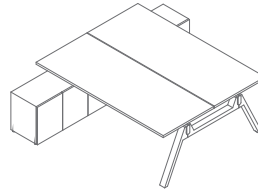

V2023
2000 / 2400 / 740
265.2 kg

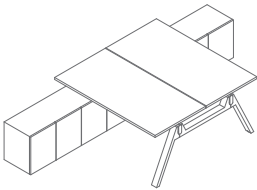

V1624
1600 / 3200 / 740
259 kg

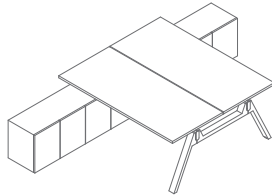

V1824
1800 / 3200 / 740
273.1 kg

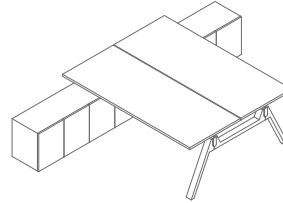

V2024
2000 / 3200 / 740
287.2 kg

Accessories *

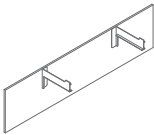

V16B
1600 / 340 / 400
11.13 kg

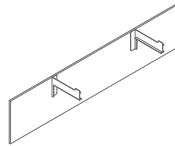

V18B
1800 / 340 / 400
11.81 kg

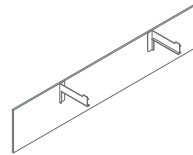

V20B
2000 / 340 / 400
12.5 kg

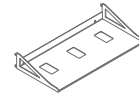

V34
550 / 280 / 85
3 kg

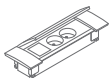

M06
245 / 80 / 50
1 kg

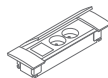

M06H
245 / 80 / 50
1 kg

* dimensions expressed in millimeters: width x depth x height

Executive desks *



V01
1800 / 1000 / 740
92.45 kg

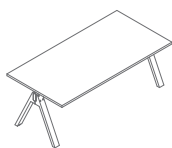

V02
2000 / 1000 / 740
100.94 kg

Desk with managerial cabinet *

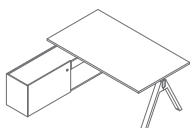

V03L
1800 / 1800 / 740
152.45 kg

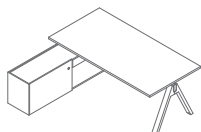

V04L
2000 / 1800 / 740
160.94 kg

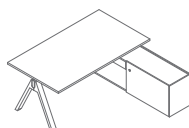

V03P
1800 / 1800 / 740
152.45 kg

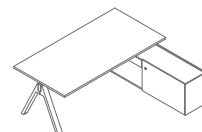

V04P
2000 / 1800 / 740
160.94 kg

Desk with managerial cabinet – cabinet with access from both sides *

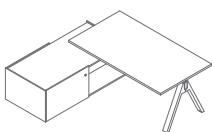

V05L
1800 / 1000 / 740
186.45 kg

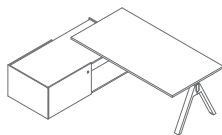

V06L
2000 / 1000 / 740
194.94 kg

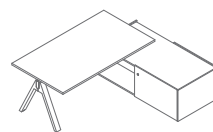

V05P
1800 / 1000 / 740
186.45 kg

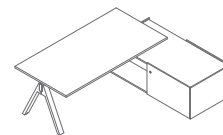

V06P
2000 / 1000 / 740
194.94 kg

Desks with pedestal *

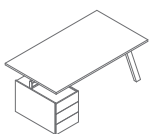

V07L
1800 / 1000 / 740
134.95 kg

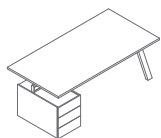

V08L
2000 / 1000 / 740
143.44 kg

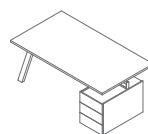

V07P
1800 / 1000 / 740
134.95 kg

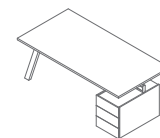

V08P
2000 / 1000 / 740
143.44 kg

* dimensions expressed in millimeters: width x depth x height

Desks with executive cabinet and pedestal *

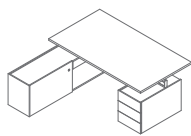

V09L
1800 / 1800 / 740
194.95 kg

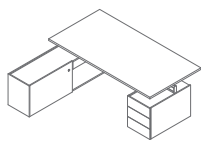

V10L
2000 / 1800 / 740
203.44 kg

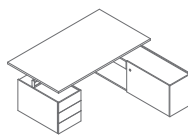

V09P
1800 / 1800 / 740
194.95 kg

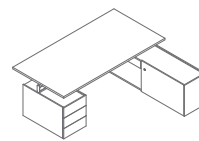

V10P
2000 / 1800 / 740
203.44 kg

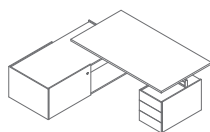

V37L
2144 / 1800 / 740
228.95 kg

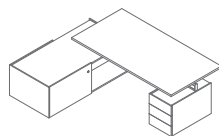

V38L
2344 / 1800 / 740
237.44 kg

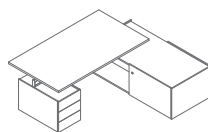

V37P
2144 / 1800 / 740
228.95 kg

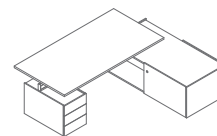

V138P
2344 / 1800 / 740
237.44 kg

Managerial storages *

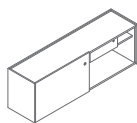

V35
1602 / 416 / 545
62.5 kg

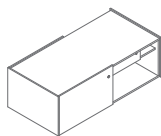

V36
1602 / 784 / 545
96.5 kg

Storages *

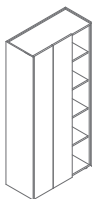

V22
928 / 424 / 1944
132 kg

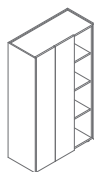

V23
928 / 424 / 1565
104.5 kg

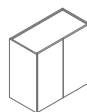

V24
828 / 424 / 807
56 kg

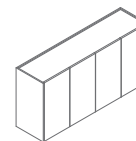

V25
1628 / 424 / 807
104 kg

* dimensions expressed in millimeters: width x depth x height

Storages *

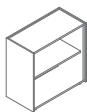

V26
828 / 424 / 807
44 kg

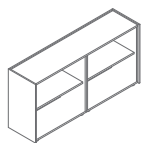

V27
1628 / 424 / 807
79 kg



V28
828 / 424 / 807
53.95 kg

Pedestals *

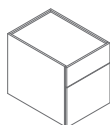

V12K
438 / 600 / 545
35 kg

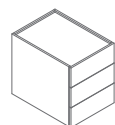

V13K
438 / 600 / 545
35 kg

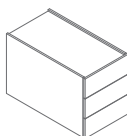

V14K
438 / 800 / 545
45 kg

Additional elements *

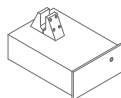

V11
436 / 600 / 216
16.5 kg

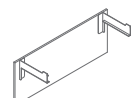

V10B
1000 / 340 / 400
7.9 kg

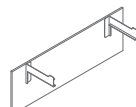

V12B
1200 / 340 / 400
8.5 kg



V34
550 / 280 / 85
3 kg

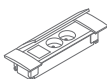

M06
245 / 80 / 50
1 kg

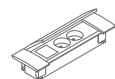

M06H
245 / 80 / 50
1 kg

* dimensions expressed in millimeters: width x depth x height

Meeting tables *



V220S
2200 / 1100 / 740
113.9 kg



V240S
2400 / 1100 / 740
123.12 kg

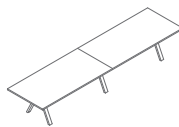

V440S
4400 / 1100 / 740
227.8 kg

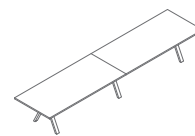

V480S
4800 / 1100 / 740
246.26 kg

High tables *



V169
1600 / 800 / 900
73.5 kg



V189
1800 / 800 / 900
80.55 kg



V209
2000 / 800 / 900
87.6 kg



V1611
1600 / 800 / 1100
74.5 kg



V1811
1800 / 800 / 1100
81.55 kg

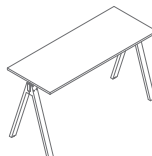

V2011
2000 / 800 / 1100
88.6 kg



V1619
1600 / 1000 / 900
81.36 kg



V1819
1800 / 1000 / 900
90.29 kg



V2019
2000 / 1000 / 900
105.22 kg

* dimensions expressed in millimeters: width x depth x height

High tables *



V16111
1600 / 1000 / 1100
182.36 kg



V18111
1800 / 1000 / 1100
91.29 kg



V20111
2000 / 1000 / 1100
106.22 kg

Elements for pairing *



V169L
1600 / 800 / 900
69.1 kg



V189L
1800 / 800 / 900
76.15 kg



V209L
2000 / 800 / 900
83.2 kg



V1611L
1600 / 800 / 1100
769.8 kg



V1811L
1800 / 800 / 1100
76.85 kg

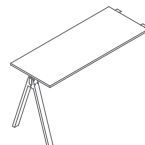

V2011L
2000 / 800 / 1100
83.9 kg



V1619L
1600 / 1000 / 900
76.96 kg



V1819L
1800 / 1000 / 900
85.89 kg



V2019L
2000 / 1000 / 900
100.82 kg

* dimensions expressed in millimeters: width x depth x height

Elements for pairing *



V16111L
1600 / 1000 / 1100
77.66 kg



V18111L
1800 / 1000 / 1100
86.59 kg



V20111L
2000 / 1000 / 1100
101.52 kg

Accessories *

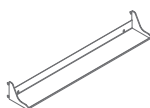

V21
700 / 120 / 85
1.8 kg

* dimensions expressed in millimeters: width x depth x height

Viga	Date of preparation 03.01.2023	The data contained in this document is valid in the day of its preparation. Change of the product, as long as it does not affect the basic features of it, does not require consistent updates of the document.	page 17/20
			products

Desks, executive desks, executive desks with managerial storage, meeting tables, high tables,

Top

Leg

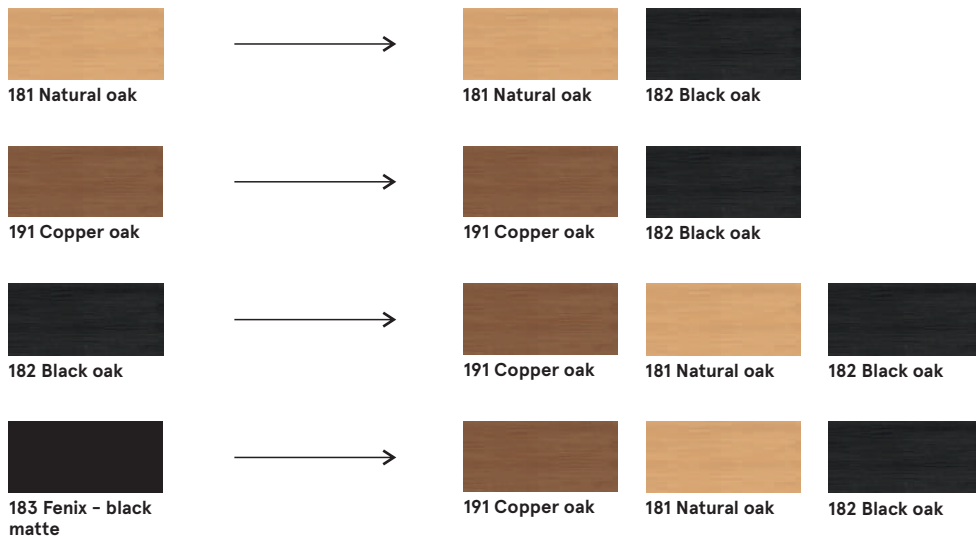

Managerial storage



Copplementary elements

Top access M10



Mediabox



No possibility to mix oak colours in one product.

Executive desks with managerial storage

Back wall



181 Natural oak



182 Black oak



191 Copper oak



183 Fenix - black matte

Body inside, front



181 Natural oak



182 Black oak



191 Copper oak

Sides of the cabinet



183 Fenix - black matte

Additional elements

Suspended box-drawer, modesty panel



181 Natural oak



182 Black oak



191 Copper oak

Top access M10



183 Fenix - black matte

Mediabox



M115 Black semi-matt RAL9005

Storages

Top, sides of the cabinet



183 Fenix - black matte

Body outside, body inside, front



181 Natural oak



182 Black oak



191 Copper oak

No possibility to mix oak colours in one product.

Pedestals

Top



Body outside



Front, body inside



Managerial storages

Top, base



Sides of the cabinet



Body inside, front

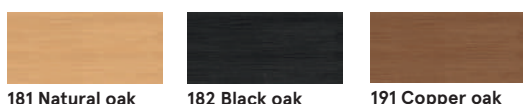

No possibility to mix oak colours in one product.