

Ogi B

technical specification



.mdd

.mdd has a leading position among manufacturers of office furniture with many awards that prove quality and continuously increase demand for its products.

The realities of today's market require constant quality improvement at all levels of modern organization. This applies in particular to customer service, marketing, quality of products and also to quality of processes within the company. Partnership relations among employees and with business partners form a base of economic growth and success of the company.

Constant investments in innovative machinery park, optimization of management systems and an expansion of production halls allow to minimize the lead times for the product of the highest quality.

More than twenty years of experience in office furniture industry come with reference from a long list of companies and institutions to show their appreciation for an efficient and comprehensive service.

.mdd is highly aware of the environment.

Being located in the forest region with lake by its side, .mdd takes the nature seriously and invests constantly in a modern and energy-efficient solutions to preserve the local life. Company puts emphasis on waste segregation and recycling. .mdd has been awarded for the exceptional care and involvement in waste disposal. All materials used are environmentally friendly and enjoy a high 95 % rate of being recycled.



Warranty:

.mdd products – 5 years.
Electrical components and fabric – 2 years.

Certificate – MFC:



Assembly:

product delivered in separate elements

Packing:

cardboard, perforated plastic mesh wrap

Compliant with standards:

PN-EN 527-2:2017-02

Boards density:

12 mm – 690 – 750 kg/m³
18 mm – 650 – 690 kg/m³
28 mm – 610 – 630 kg/m³
36 mm – 610 – 630 kg/m³

Material composition *:

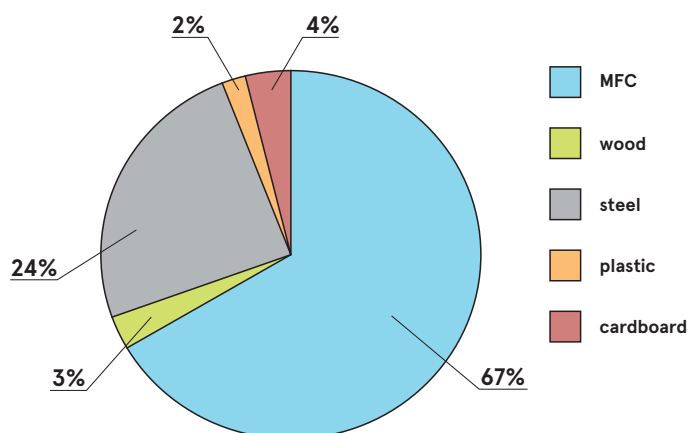

* according to the EPD document

Recyclability **

Recycling: 37% - Downcycling: 63%

Recycled content

63%

Co2 carbon footprint

67,9 kg

** average values for a representative of the group; values may vary for other products

Ogi desk worktops

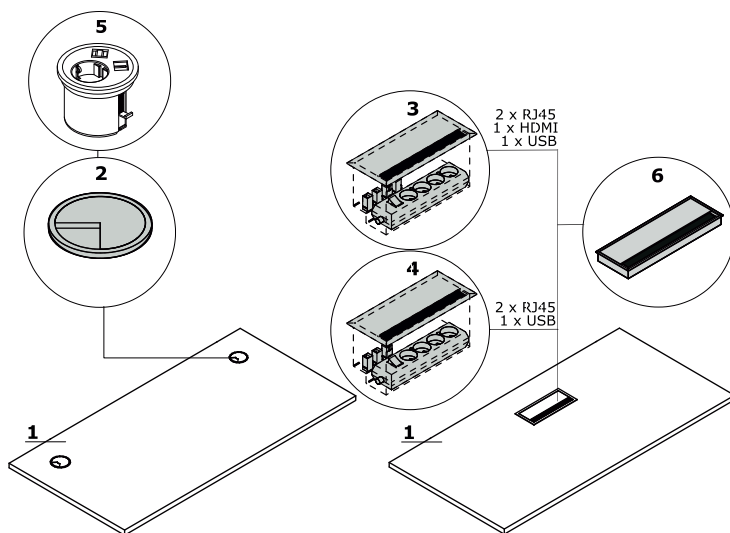

1. **Worktop** - MFC 28 mm, ABS edge
- OPTIONS WITH EXTRA CHARGE:**
2. **Grommet** - 2 pcs, Ø 80 mm
3. **Mediabox M04H** - 2 x RJ45 (class E, cat. 6); + 1 x USB + 1 x HDMI + 4 x 230V
4. **Mediabox M04** - 2 x RJ45 (class E, cat. 6); + 1 x USB + 4 x 230V
5. **Mediabox M07** - 1 x 230V + 1 x USB charger + 1 x RJ45, colour: black, white, mounted instead of the existing grommet Ø80 mm (Pk80)
6. **Top access M05**
7. **Cable way** - the width of the opening is proportional to the width of the worktop
8. **Mediabox M07 + cable grommets**
9. **Cable way + cable grommets** - desks, bench desks

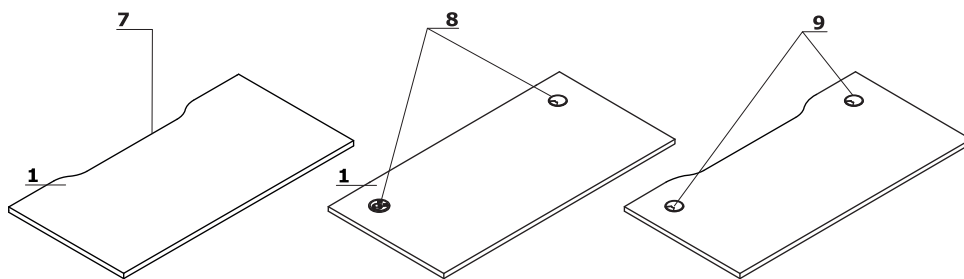

Frame

Ogi B - natural wood - ash, coated with transparent varnish, profile 40 x 56 mm, spacer 10 mm between top and frame

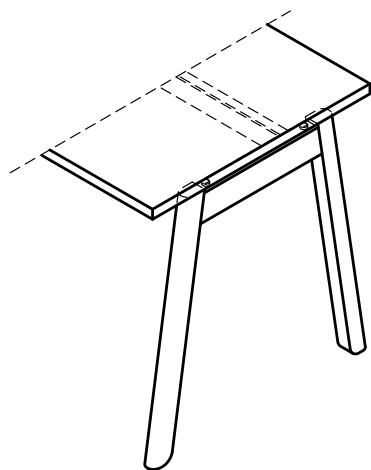

Attention - leveling - 10 mm range

Attention - cable tray under the worktop is always in M009 - aluminium semi-matt colour.

Ogi B	Date of preparation 03.11.2022	The data contained in this document is valid in the day of its preparation. Change of the product, as long as it does not affect the basic features of it, does not require consistent updates of the document.	page 3/7 technical description
-------	-----------------------------------	---	-----------------------------------

Accessories

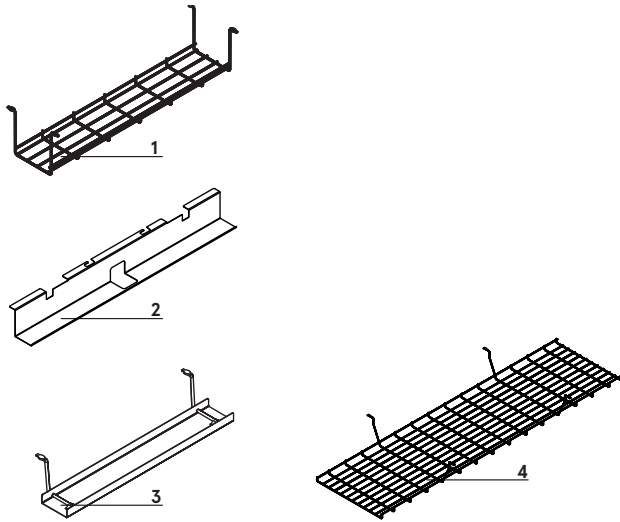

1. Horizontal cable tray S69 - powder coated
2. Single desk horizontal cable tray (SG12, SG16) - powder coated metal
3. Horizontal cable tray E64 - powder coated
4. Cable tray for bench desks (SG220, SG260) - steel wire Ø4 mm, powder coated

Sliding top

1. Sliding top - shifting range 141 mm
2. Tabletop sliding lock

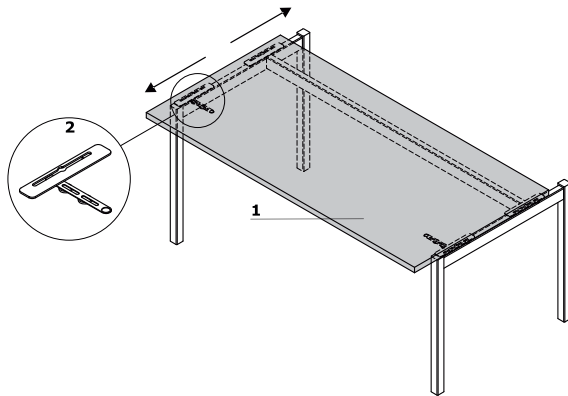

Note - M04, M04H, and M07 mediaboxes cannot be installed.

Desks *



BOB10
1000 / 600 / 740
23.3 kg



BOB12
1200 / 600 / 740
25.3 kg

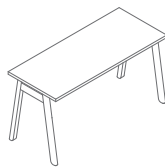

BOB14
1400 / 600 / 740
45.15 kg

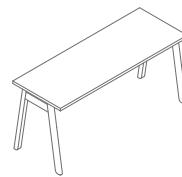

BOB16
1600 / 600 / 740
31.5 kg

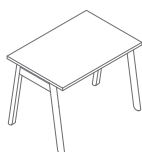

BOB19
1000 / 700 / 740
24.8 kg

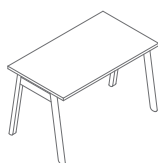

BOB22
1200 / 700 / 740
31 kg

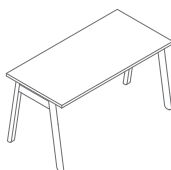

BOB24
1400 / 700 / 740
57.6 kg

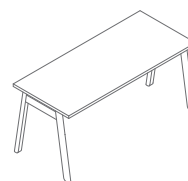

BOB26
1600 / 700 / 740
39.5 kg

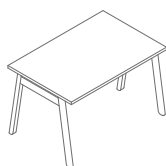

BOB02
1200 / 800 / 740
34 kg

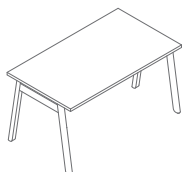

BOB03
1400 / 800 / 740
36.5 kg

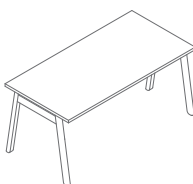

BOB04
1600 / 800 / 740
41.55 kg

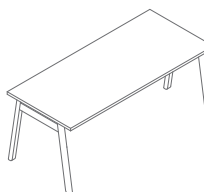

BOB05
1800 / 800 / 740
45.55 kg

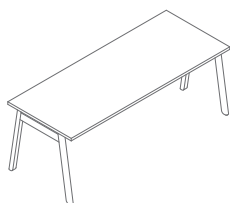

BOB06
2000 / 800 / 740
45.59 kg

www.mdd.eu

* dimensions expressed in millimeters: width x depth x height

Bench desks *

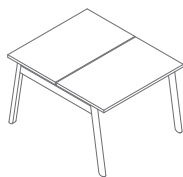

BOB50
1000 / 1210 / 740
41.6 kg

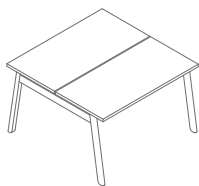

BOB52
1200 / 1210 / 740
45.6 kg

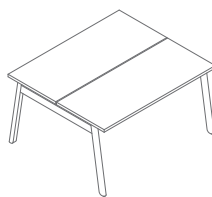

BOB54
1400 / 1210 / 740
56 kg

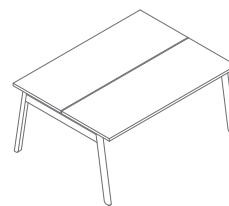

BOB56
1600 / 1210 / 740
58 kg

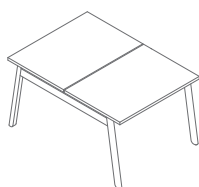

BOB48
1000 / 1410 / 740
45.6 kg

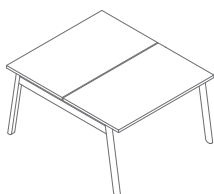

BOB42
1200 / 1410 / 740
58 kg

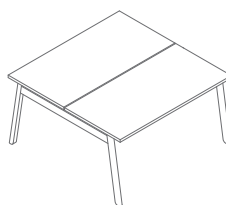

BOB44
1400 / 1410 / 740
61.2 kg

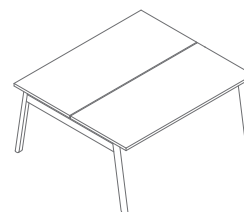

BOB46
1600 / 1410 / 740
75 kg

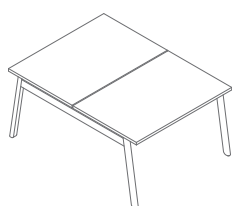

BOB32
1200 / 1610 / 740
63 kg

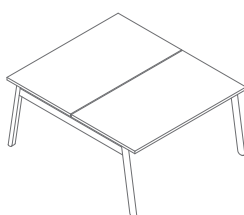

BOB33
1400 / 1610 / 740
68 kg

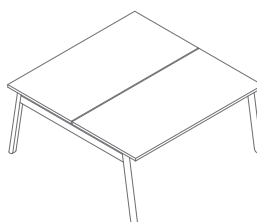

BOB34
1600 / 1610 / 740
78.1 kg

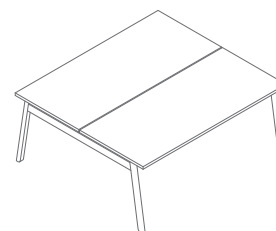

BOB35
1800 / 1610 / 740
86.1 kg

www.mdd.eu

Desk extensions *



PLB01
600 / 800 / 740
16.1 kg



PLB02
600 / 100 / 740
18.1 kg

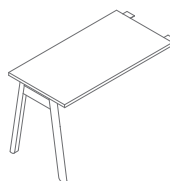

PLB03
600 / 1200 / 740
20.6 kg

* dimensions expressed in millimeters: width x depth x height

Worktop, top, base, body, front



Base



Grommets



Accessories

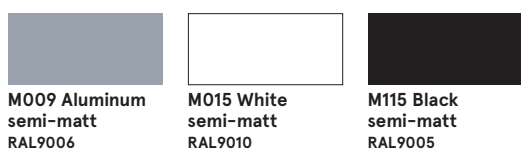

* body - II group
 ** OPTION WITH EXTRA CHARGE - worktop edge, colour: ash natural
 *** the colour of desk legs may differ depending on natural wood ring pattern