



LOOP

Conquering acoustic and lighting issues in the workplace. Loop deals with both simultaneously.



ABSORPTION



LOW, MEDIUM
& HIGH TONES

MUTE.

GENERAL

Type: Pendant

Light version: LED (available with Opaque or Microprism diffuser)

Recommended use: Workstations, Open-spaces & Conference rooms

COMPOSITION

- Fabric of choice
- HDF board
- Felt
- Basotect foam
- Source of light (plexiglass, steel, aluminium)
- Aluminium

SHAPE AND DIMENSIONS mm

+/- 5mm

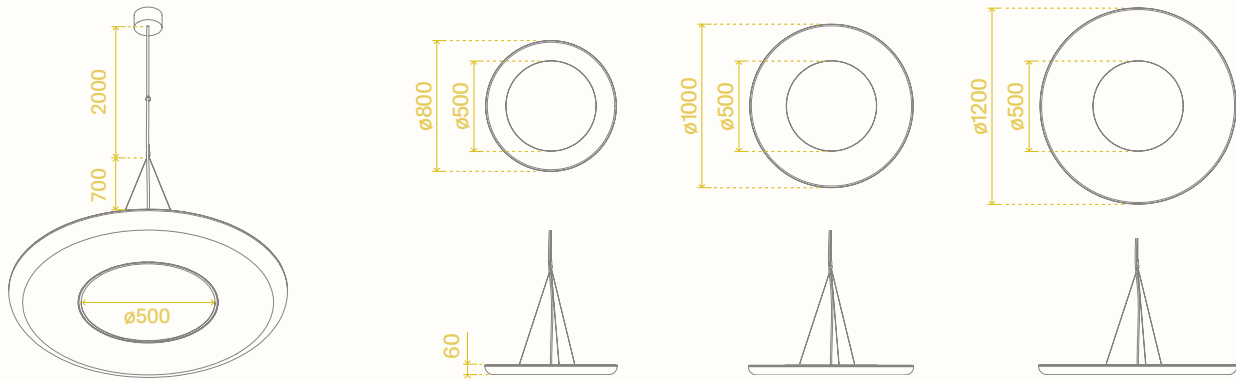

WEIGHTS kg

ø800	ø1000	ø1200
7	10	13

ACOUSTIC PROPERTIES



Absorption



Low, medium and high tones

FIXING SYSTEM

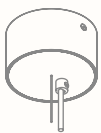

The ceiling canopy (ø100×55 mm) is available in white (RAL 9016) or black (RAL 9005).

The lamp is delivered with a power cable and a mounting system (3 m) – see the Shape and Dimensions section above.

PACKAGING (LxWxH)

Depending on the size, the product is shipped in following sizes of packaging:

- 820×820×85 mm
- 1020×1020×85 mm
- 1220×1220×85 mm

SOUND ABSORPTION A_{OBJ} PER ISO 354

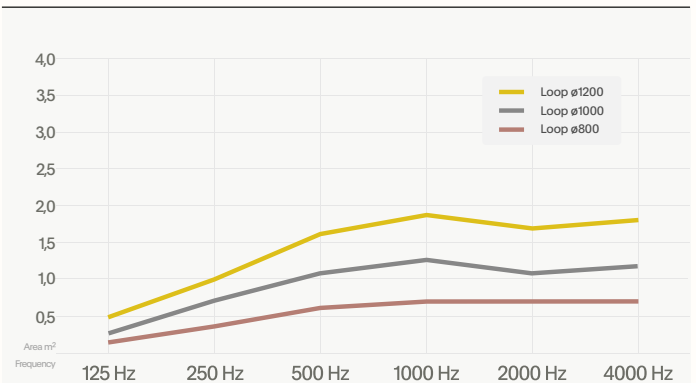

A _{obj} m ²	125 Hz	250 Hz	500 Hz	1000 Hz	2000 Hz	4000 Hz
ø1200	0,5	1,0	1,6	1,9	1,7	1,8
ø1000	0,3	0,7	1,1	1,3	1,1	1,2
ø800	0,2	0,4	0,6	0,7	0,7	0,7

LED OPAQUE LIGHT SOURCE PROPERTIES



Wattage: 18 W
 Input Voltage: 230 VAC
 Lumen Output: 2500 lm
 Efficacy: 139 lm/W
 Color Temperature: 3000K / 4000K
 CRI: >90
 UGR: 21
 Colour tolerance: MacAdam 3
 Average rated life: L90B20 50 000 h
 Degree of protection: IP40
 Dimming: Dali (Optional)
 Certificates: CE

LED MICROPRISM LIGHT SOURCE PROPERTIES



Wattage: 18 W
 Input Voltage: 230 VAC
 Lumen Output: 2300 lm
 Efficacy: 128 lm/W
 Color Temperature: 3000K / 4000K
 CRI: >90
 UGR: 19
 Colour tolerance: MacAdam 3
 Average rated life: L90B20 50 000 h
 Degree of protection: IP40
 Dimming: Dali (Optional)
 Certificates: CE

LED OPAQUE PHOTOMETRIC DISTRIBUTION

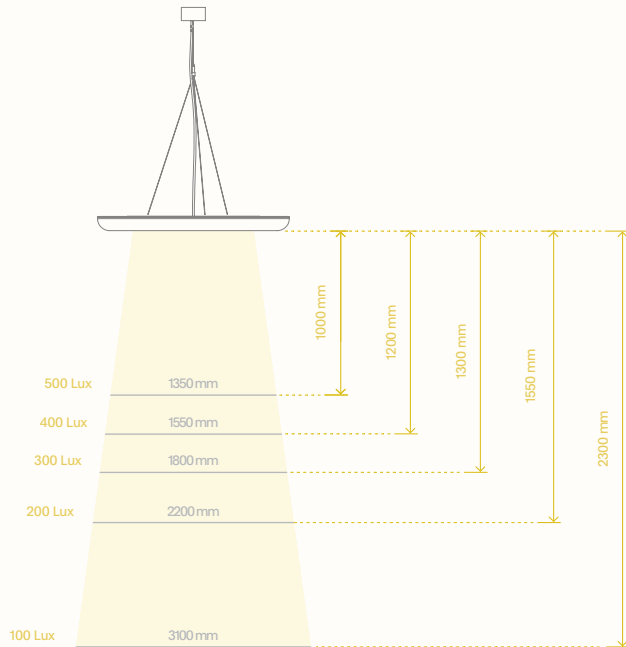

LED MICROPRISM PHOTOMETRIC DISTRIBUTION

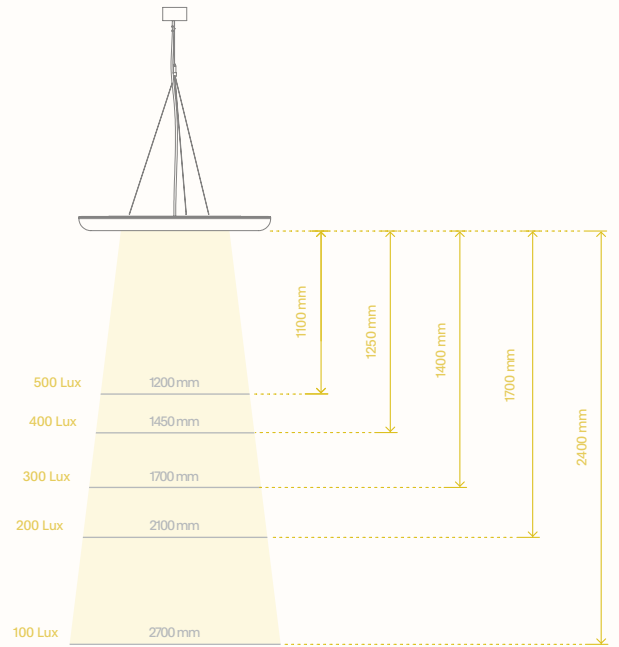

Polar intensity diagram
LED ø500 with Opaque diffuser

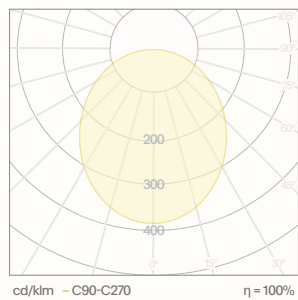

Light distribution
LED ø500 with Opaque diffuser

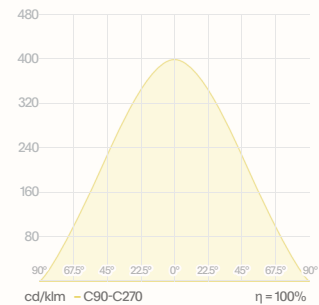

Polar intensity diagram
LED ø500 with Microprism diffuser

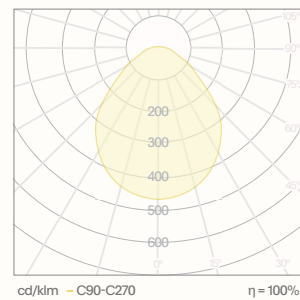



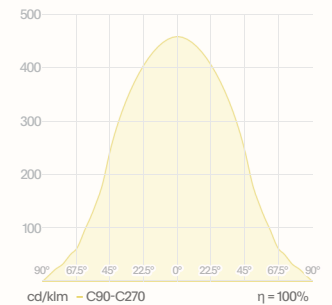





Light distribution
LED ø500 with Microprism diffuser

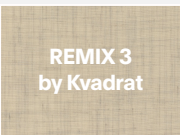

SELECTION OF STANDARD FABRICS

 THE ENTIRE COLOR PALETTE IS AVAILABLE ON [HTTPS://MUTE.DESIGN](https://mute.design)

NAME	PG	COMPOSITION	WEIGHT g/m ²	WIDTH mm	FLAMMABILITY certificates	LIGHT FASTNESS ISO 105-B02	PILLING RES. ISO 12945-2
 ERA by Camira	1	100% polyester	320	140	BS EN 1021-1 BS EN 1021-2	5	4
 EVO		100% polyester	300	160	BS EN 1021-1 BS EN 1021-2	4-5	5
 MEDLEY by Gabriel	2	100% polyester	364	140	BS EN 1021-1 BS EN 1021-2	5-7	5-7
 MICA by Gabriel		97% post-cons. recycled polyester, 3% polyester	218	140	BS EN 1021-1 BS EN 1021-2	5-8	4-5
 SPRINT by Camira		100% polyester	325	150	BS EN 1021-1 BS EN 1021-2	6	4
 CHILI by Gabriel	3	75% post-cons. recycled polyester, 25% polyester	336	140	BS EN 1021-1 BS EN 1021-2 DIN 4102-B1	5-8	4-5
 SYNERGY by Camira		95% new wool, 5% polyamide	400	140	BS EN 1021-1 BS EN 1021-2	5	4
 REMIX 3 by Kvadrat	4	90% new wool, 10% nylon	300	140	BS EN 1021-1 BS EN 1021-2	6	3-4
 SELECT by Gabriel		85% New Zealand wool, 15% polyamide	364	140	BS EN 1021-1 BS EN 1021-2	5-8	4-5
 STEELCUT TRIO 3 by Kvadrat	5	90% new wool, 10% nylon	550	140	BS EN 1021-1 BS EN 1021-2	6-7	4

CARE

- Keep the product dry and away from air conditioning and ventilation systems
- Keep away from direct sun light and heat sources
- Vacuum regularly